

INSTALLATION INSTRUCTIONS USER GUIDE

Side by side refrigerator

RX611DUX, RX628DX
and RX628DW models

NZ AU GB IE

Fisher & Paykel

CONTENTS

Introduction	2
Safety and warnings	3
Installation instructions	7
Moving and storing your appliance	15
About your refrigerator – Ice & Water	16
About your refrigerator – Non Ice & Water	17
Operating instructions – Ice & Water control panel	18
Operating instructions – Non Ice & Water control panel	22
Using your water dispenser/Ice maker – Ice & Water	25
Special features	27
Cleaning Care – Exterior	28
Cleaning Care – Interior	29
Storing food in your refrigerator	30
Storing food in your freezer	32
Troubleshooting	34
Manufacturer's Warranty	38
Customer Care	40
European Directive 2012/19/EU on Waste Electrical and Electronic Equipment (WEEE)	42

IMPORTANT!

SAVE THESE INSTRUCTIONS

The models shown in this user guide may not be available in all markets and are subject to change at any time. For current details about model and specification availability in your country, please go to our website www.fisherpaykel.com or contact your local Fisher & Paykel dealer.

Note that the word "refrigerator" refers to combination refrigerator/freezer products.

Registration

Register your product with us so we can provide you with the best service possible.

To register your product visit our website: www.fisherpaykel.com

INTRODUCTION

Thank you for buying a Fisher & Paykel side by side refrigerator.

This refrigerator combines size and storage space with the latest features and functions. Many hours have been spent researching how you, our customer, use your refrigerator and what we can do to make life easier for you.

As your life changes, so can your refrigerator. This book explains the features and functions, and will help you get the most out of your refrigerator.

We hope you enjoy your new side by side refrigerator.

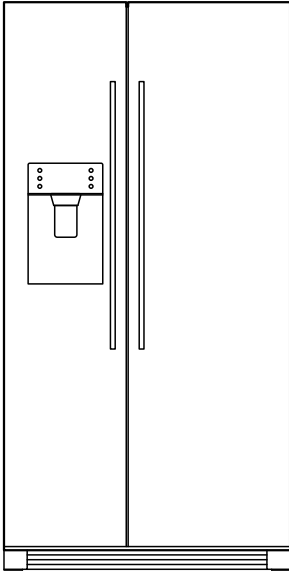

RX611DUX

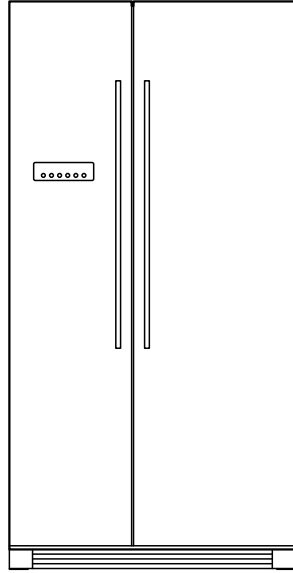

RX628DW/RX628DX

⚠ WARNING!



Electric Shock Hazard

Read and follow the safety and warnings outlined in this user guide before operating this appliance.

Failure to do so can result in death, electric shock, fire or injury to persons.



This refrigerator contains flammable refrigerant Isobutane (R600a).

Use this appliance only for its intended purpose as described in this user guide.

IMPORTANT SAFETY INSTRUCTIONS

WARNING! When using this appliance always exercise basic safety precautions including the following:

- **This appliance is not intended for use by persons (including children under the age of 8 years) with reduced physical, sensory or mental capabilities, or lack of experience and knowledge, unless they have been given supervision or instruction concerning use of the appliance by a person responsible for their safety.**
- **Young children should be supervised to ensure they do not play with the appliance.**
- **The manufacturer's installation instructions for product and cabinetry ventilation must be followed when installing the appliance.**
- **Keep ventilation openings, in the appliance enclosure or in the built-in structure, clear of obstruction.**

- **Do not use mechanical devices or other means to accelerate the defrosting process.**
- **Do not damage the refrigerant circuit.**
- **In case of damage to the refrigerant circuit, ventilate the area by opening all windows. Do not operate electrical equipment or any other equipment that may produce arcs, sparks or flames in the area. Contact your Fisher & Paykel trained and supported service technician immediately to arrange for the appliance to be repaired.**
- **It is hazardous for anyone other than an authorised service person to service this appliance. In Queensland the authorised service person must hold a gas work licence or authorisation for hydrocarbon refrigerants to carry out service or repairs which involve removal of covers.**

Electrical

- **This appliance must be installed in accordance with the installation instructions before use.**
- **Never unplug your refrigerator by pulling on the power cord.**
- **Always grip the plug firmly and pull straight out from the outlet.**
- **Do not plug in any other appliance at the same power point as your refrigerator or use extension cords or double adapters.**
- **Repair or replace immediately all electric service cords that have become frayed or otherwise damaged. Do not use a cord that shows cracks or abrasion along its length or at either the plug or appliance end.**
- **If the power supply cord is damaged, it must only be replaced by your Fisher & Paykel trained and supported service technician because special purpose tools are required.**

- **When moving your appliance away from the wall, be careful not to roll over or damage the power cord.**
- **Do not use electrical appliances inside the food storage compartments of the appliance.**

IMPORTANT!

Your refrigerator is designed to operate for many years without the need for service checks. However, if your refrigerator is malfunctioning, have it attended to by your Fisher & Paykel trained and supported service technician as soon as possible. All electrical repairs must be carried out by an adequately trained service technician or qualified electrician.

Cleaning

Many commercially available cleaning products contain solvents which may attack plastic components of your refrigerator and cause them to crack. Please refer to the cleaning care section of this booklet for further advice.

Disposal

Extreme care must be taken when disposing of your old appliance to avoid hazards:

- **The flammable refrigerant gas must be safely removed.**
- **The thermal insulation foam contained in this appliance is produced by flammable insulation blowing gases, any exposed foam may be highly flammable and must be carefully treated during disposal.**
- **The doors should be removed and the shelves left in place so that children may not easily climb inside.**

- **Your Fisher & Paykel trained and supported service technician will be able to give advice on environmentally friendly methods of disposing of your old refrigerator or freezer.**

Storing food and drinks

- **Do not store explosive substances such as aerosol cans with a flammable propellant in this appliance.**
- **Never store volatile or flammable materials in your refrigerator as they may explode.**
- **Never freeze liquids in glass containers. Liquid expands during freezing, which may cause the container to explode.**
- **Never freeze carbonated drinks. They may explode.**
- **Do not consume food if it is too cold. Food removed from the freezer compartment may be cold enough to cause damage when brought into contact with bare skin, eg frozen ice cubes.**

Power failure – food safety

- **Do not refreeze frozen foods that have thawed completely. The food may be dangerous to eat. Follow the recommendations below if you discover food in your freezer has thawed:**
 - **Ice crystals still visible – food may be refrozen but should be stored for a shorter period than recommended.**
 - **Thawed but refrigerator cold – refreezing generally not recommended. Fruits and some cooked food can be refrozen but use as soon as possible. Meat, fish, poultry – use immediately or cook then refreeze. Vegetables – discard as they usually go limp and soggy.**
 - **Thawed and warmer than 5°C – discard all food.**

INSTALLATION INSTRUCTIONS

Please follow the installation steps below to ensure your appliance operates correctly.

Power

- The appliance must be installed so the plug is accessible.
- To ensure that the appliance is not accidentally switched off, connect your refrigerator to its own power point. Do not plug in any other appliance at this power point or use extension cords or double adaptors, as the combined weight of both power cords can pull a double adaptor from the wall outlet socket.
- For power requirements, refer to the information on the serial plate located on the left hand side of the fridge compartment.
- It is essential that the appliance is properly grounded (earthed).
- Connect the appliance to the electrical supply (220-240 V-50 Hz) with the plug and lead, which are fitted.
- Connections to the mains supply should be in accordance with local regulations.

Location

- Your refrigerator should not be located in direct sunlight or next to any heat generating appliance such as a cooktop, oven or dishwasher.
- This appliance is intended to be used in households and similar applications such as
 - staff kitchen areas in shops, offices and other working environments;
 - farm houses and by clients in hotels, motels and other residential type environments;
 - bed and breakfast type environments;
 - catering and similar non-retail applications.

Ice & Water (Ice & Water models only)

- Your Ice & Water refrigerator must be installed by an authorised plumber or Fisher & Paykel trained and supported service technician as incorrect plumbing can lead to water leaks.
- Fisher & Paykel Appliances does not accept responsibility for damage (including water damage) caused by faulty installation or plumbing.

INSTALLATION INSTRUCTIONS

Product and cabinetry dimensions

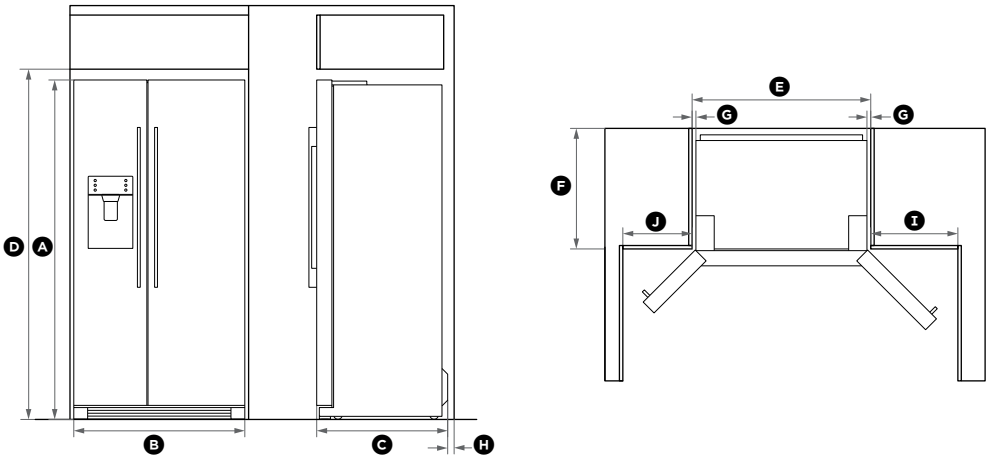

PRODUCT DIMENSIONS

- (A) Overall height of product
(to top of hinge)
- (B) Overall width of product
- (C) Overall depth of product
(excludes handle, includes rear cover)

mm

1795

910

700

CABINETRY DIMENSIONS

- (D) Inside height of cavity

1845

Flush with refrigerator chassis – full door rotation

- (E) Inside width

950

- (F) Inside depth

635

MINIMUM CLEARANCES

- (G) Side clearance

20

- (H) Rear clearance

30

- (I) Door clearance - hinge side flush with chassis – full rotation

460

- (J) Door clearance - hinge side flush with chassis – full rotation
(Small Door)

365

INSTALLATION INSTRUCTIONS

Positioning your appliance

Choosing the right location

This appliance should be installed in a room that is dry and well ventilated. To provide adequate ventilation, make sure the refrigerator is at least 20 mm clear on all sides from kitchen cabinetry, and 30 mm from the back wall. Any units placed above the appliance must be clear by 50 mm to allow sufficient ventilation.

If locating the refrigerator close to a corner, sufficient spacing must be left for opening the doors and removing the shelves.

This appliance should be at least 100 mm from any electric or gas cooker. If this is not possible, make sure that appropriate insulation is used (eg insulated wall).

Avoid exposing the appliance to direct sunlight, and sources of heat (such as radiators, heaters or cookers).

Locating this appliance in a cold environment (such as a shed, outhouse or garage) may compromise its performance. A consistent room temperature of 10°C or above is recommended to ensure optimum performance and food care.

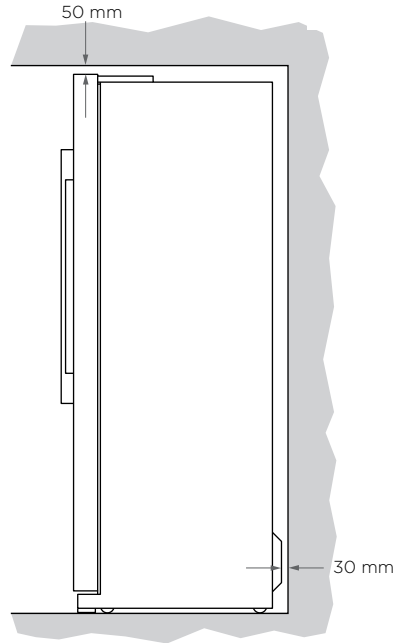

Installation distance

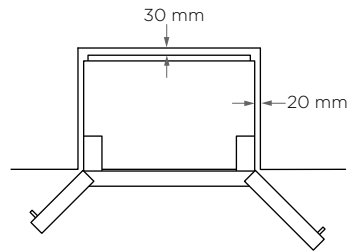

Door rotation installation distance

INSTALLATION INSTRUCTIONS

Removing and installing the doors

IMPORTANT!

- In the event that you need to remove the refrigerator doors, please follow the door removal and installation instructions below.
- It is suggested for your safety to have two or more people to assist you in completing the tasks below to avoid injury, product damage or property loss.
- Ensure both power and water to the refrigerator are turned off.

First step to removing fridge and freezer door

- ① Undo the 2 screws holding kick-strip in position and remove (Fig.1).
- ② Release the water coupler: press and hold in the collet as shown (Fig.2) and remove the water tube.

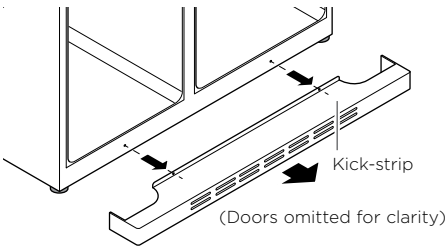

Fig.1 Removing kick-strip

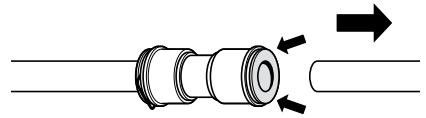

Fig.2 Releasing water coupler

The freezer door

- ① Undo the hinge cover screw and remove the cover (Fig.3), the clips holding the cover must be released first. Unclip the front section of the hinge cover, then push the cover towards the centre of the appliance and pull upwards to release.
- ② Disconnect wires held together with clips (Fig.3).
- ③ Undo the screws holding down hinge bracket. Do not disconnect the earth wire from the screw (Fig.4).
- ④ Lift freezer door and thread the water tube up through the lower hinge.
- ⑤ Pull the door up and then away from the cabinet.

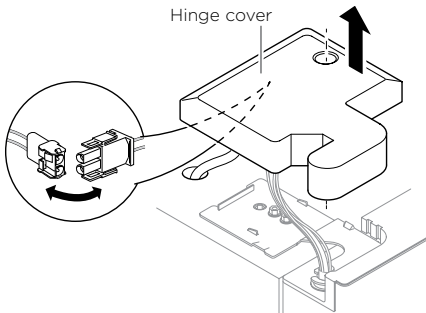

Fig.3 Removing hinge cover

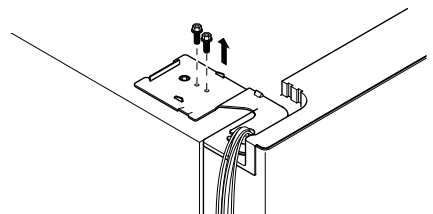

Fig.4 Removing hinge screws

INSTALLATION INSTRUCTIONS

The fridge door

- ① Undo the hinge cover screw and remove the cover (Fig.5), the clips holding the cover must be released first. Unclip the front section of the hinge cover, then push the cover towards the centre of the appliance and pull upwards to release.
- ② Undo screws holding down the hinge bracket (Fig.6).
- ③ Pull the door up and then away from the cabinet.

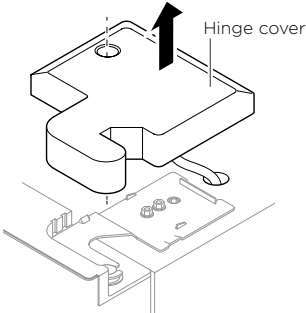

Fig.5 Removing hinge cover

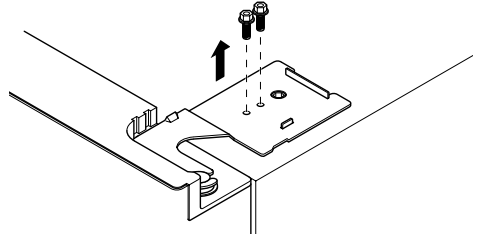

Fig.6 Removing hinge screws

Refitting the doors

Refit the doors by reversing the removal steps. It is essential that when you replace the freezer door you replace the earth wire.

INSTALLATION INSTRUCTIONS

Levelling the refrigerator and adjusting the doors

Make sure that the appliance is on solid level flooring. If the refrigerator is placed on a plinth, the plinth must be flat and constructed from strong, fire resistant materials.

The refrigerator may require some alignment before connecting to the power supply.

This refrigerator has front adjustable feet, which can be used to level the appliance.

Insert a suitable flat-head screwdriver into the slots of the adjustable feet. Wind to the left to raise the foot and to the right to lower the foot.

Levelling the doors

To raise the left-hand door wind the left-hand foot to the left.

To raise the right-hand door, wind the right-hand foot to the left.

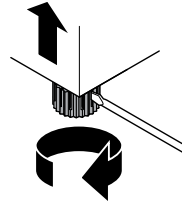

Clockwise to raise feet

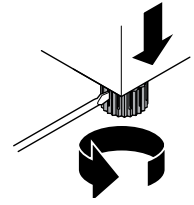

Counter-clockwise to lower feet.

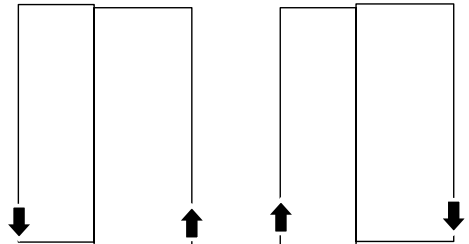

Levelling doors

INSTALLATION INSTRUCTIONS

Water supply connection

IMPORTANT!

- It is recommended to have this product installed by a Fisher & Paykel trained and supported service technician.
- DO NOT use with water that is microbiologically unsafe or of unknown quality.
- **WARNING** - connect to potable water supply only to ensure water hygiene in the ice maker and water dispenser.
- DO NOT install on line pressure above 125 PSI (860kPa) or below 4.5 PSI (30kPa).
- DO NOT use on hot water supply. Maximum temperature 38°C (100°F)
- DO NOT cut any length of tube shorter than 500 mm.
- DO NOT install near electrical wires or water pipes that will be in the path of drilling when selecting the location of the filter system.
- DO NOT mount the filter in such a position that it will be struck by other items, such as wastebaskets, etc.
- DO NOT install the filter or any water tubing in direct sunlight as prolonged exposure to light can weaken plastic components.
- DO NOT install the filter in a location that is susceptible to freezing temperatures as damage to the filter housing could occur.
- DO NOT screw the filter to the refrigerator.
- DO NOT install the filter or any water tubing in high temperature areas eg in a ceiling cavity.
- AVOID contamination of pipes during installation.
- DO NOT use copper tubing. The plastic tubing supplied should always be used.
- DO NOT continuously dispense water for a period longer than 1 minute.
- The water connection instructions are intended for a Fisher & Paykel trained and supported service technician.

INSTALLATION INSTRUCTIONS

Fitting the water filter

- ① Measure out and cut the length of tube required from the filter to the refrigerator, and from the filter to the water supply. When cutting, make sure tube ends are square and clean.
- ② Note flow direction on filter side to ensure water runs the correct way (Fig.8).
- ③ Push fit one of the tubes into the water filter (Fig.7).
- ④ Secure the tube to the filter by sliding a locking clip into the groove as shown (Fig.8).
- ⑤ Repeat the procedure on the other end of the filter.
- ⑥ Connect the end into the plastic adaptor (Fig.9). Screw the adaptor onto a suitable $\frac{3}{4}$ BSP connector water outlet.
- ⑦ Open the water valve to flush 19 L (5 gal) of water through the filter to remove any trapped air. Check for leakage in the water tube connections.
- ⑧ Access the water valve assembly at the back of the refrigerator. Push the tube into the valve assembly.

Note: extra accessories in water kit are for T line junctions these are not needed for all markets.

Before you start using the water dispenser

Before first use, run through and discard the first 3 L of water from the dispenser, stopping intermittently to remove trapped air in the system. Do not press and hold for more than 1 minute to prevent overheating of the pad activator solenoid.

Note: there will be a delay while the tank fills until water is dispensed.

IMPORTANT!

- **All connections must be checked for leaks.**
- **Ensure white $\frac{1}{4}$ " tubing is routed away from sharp objects, sharp corners (beware of kinking tube as this will stop water flow), clear of the refrigerator unit compartment and not in a location where it can be squashed.**
- **Ensure all push-fit connections are firmly pushed into place.**
- **If tubing is removed at any point, re-cut the end and re-insert. Tubing must be fully inserted to avoid leaks.**
- **To remove tube from connection points, turn off the tap, gently push the dispensing pad using a glass or container to remove static line pressure, push in the collet and gently pull tubing at the same time.**

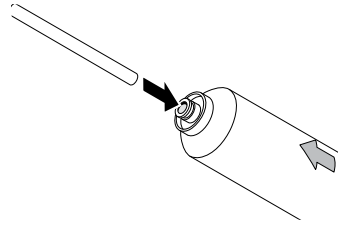

Fig.7 Filter connection

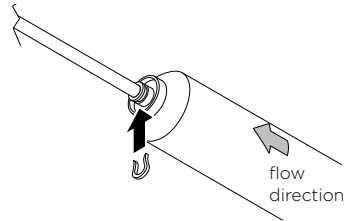

Fig.8 Locking clip

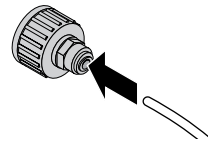

Fig.9 Waterline connection

MOVING AND STORING YOUR APPLIANCE

If your refrigerator is turned off for any reason, wait 10 minutes before turning it back on. This will allow the refrigeration system pressures to equalise before restarting.

Moving your appliance

- Turn off the appliance and unplug from the power point. Remove all food.
- Ease the appliance out of its position. Tuck the power cord away, if applicable tape the shelves in place and tape the doors closed. If the cabinet needs to be placed at an angle or laid down, carefully lay it on its side (the right-hand side when viewed from the front).
- Relocate and install. If the appliance has been left on its side for any length of time, leave it standing upright as long as possible (at least a few hours) before turning it on.

Storing your appliance

- When storing your cleaned appliance, leave the door(s) open. This allows air to circulate and prevents the build up of bacteria and moulds.
- Before using again, clean well using a mixture of warm water and baking soda (add 1 tsp of baking soda to each 500 ml of water). Rinse with clean water.

Holiday time

We recommend you leave your refrigerator operating while you are on holiday.

- Turn the ice maker off on the control panel.
- Shut off the water supply to the refrigerator.
- On your return, turn on the water supply to the refrigerator.
- Dispense 3 L of water and discard to ensure the water tank is refilled with fresh water.
- Turn on the ice maker.
- Discard the first 3 harvests of ice.

ABOUT YOUR REFRIGERATOR - ICE & WATER

RX611DUX

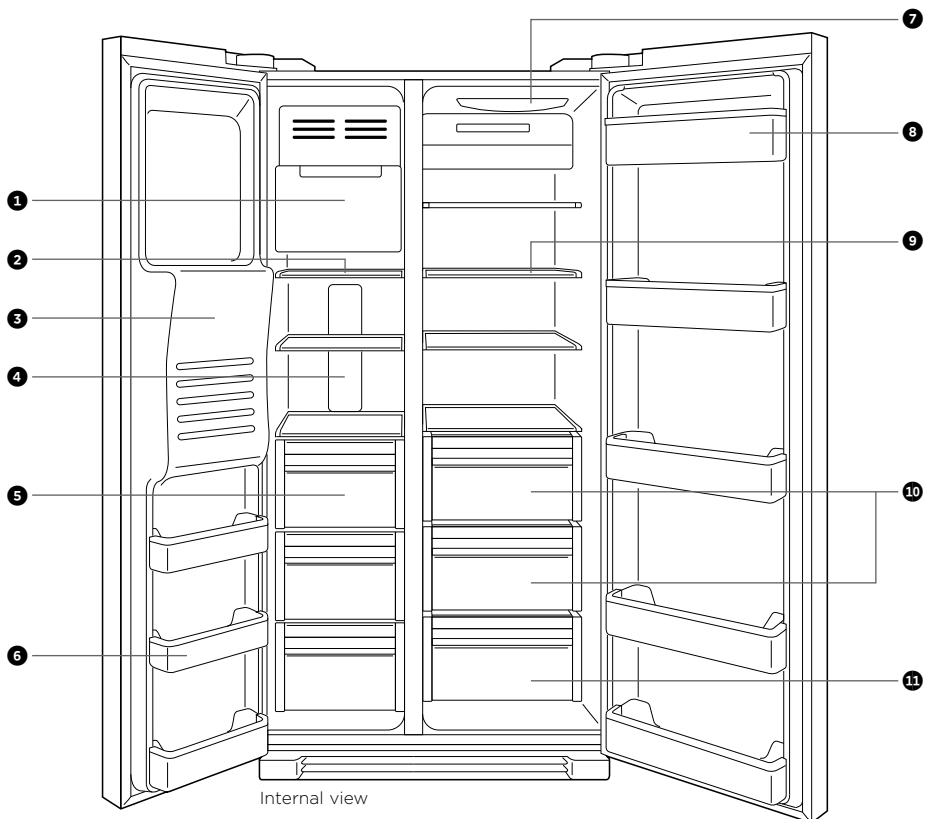

- ① Ice maker/ice box
- ② Freezer shelves
- ③ Ice & water dispenser
- ④ Freezer light
- ⑤ Freezer drawers
- ⑥ Freezer door shelves
- ⑦ Fridge light
- ⑧ Fridge door shelves
- ⑨ Fridge shelves
- ⑩ Vegetable drawers
- ⑪ Fridge drawer

ABOUT YOUR REFRIGERATOR - NON ICE & WATER

RX628DX and RX628DW

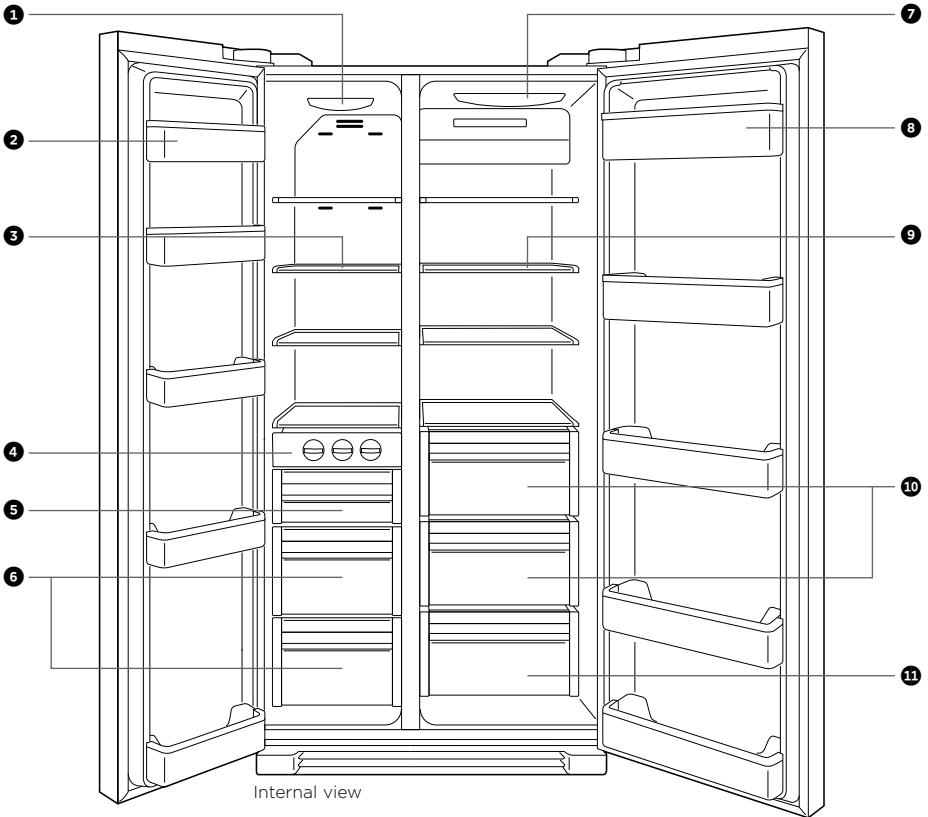

- ① Freezer light
- ② Freezer door shelves
- ③ Freezer shelves
- ④ Ice trays
- ⑤ Ice box
- ⑥ Freezer drawers
- ⑦ Fridge light
- ⑧ Fridge door shelves
- ⑨ Fridge shelves
- ⑩ Vegetable drawers
- ⑪ Fridge drawer

OPERATING INSTRUCTIONS - ICE & WATER CONTROL PANEL

Ice & water control panel

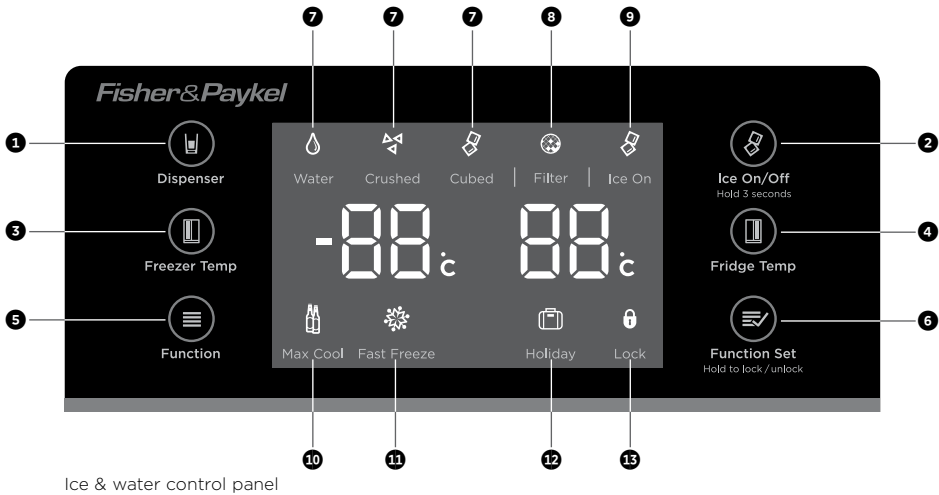

- ① Water and ice dispenser button
- ② Ice maker on/off button
- ③ Freezer temperature button
- ④ Fridge temperature button
- ⑤ Function select button
- ⑥ Function set button
- ⑦ Dispenser status icons
- ⑧ Filter change status icon
- ⑨ Ice maker on status icon
- ⑩ Max Cool icon
- ⑪ Fast Freeze icon
- ⑫ Holiday icon
- ⑬ Lock icon

Lock function

This feature will lock the temperature and function settings preventing these from being changed. This is useful when cleaning your refrigerator. When locked, the Lock icon will blink and a beep will sound.

To lock

Press and hold Function Set  for 3 seconds. The Lock icon will appear and the refrigerator settings will be locked.

To unlock

Press and hold Function Set  for 3 seconds. The Lock icon will turn off and the refrigerator settings will be unlocked.

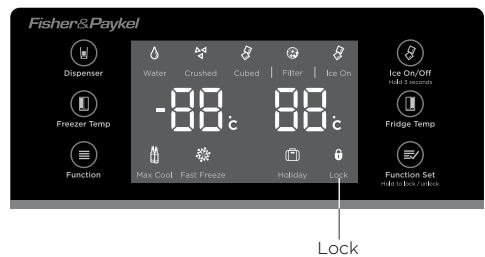

Holiday function

IMPORTANT!

Before selecting the holiday function remove all perishable food and drink from the fridge compartment as perishable items may become unsafe to consume.

This feature allows you to leave the fridge section unused while the freezer section operates as normal. When in this function, the fridge temperature will be automatically set to 17°C.

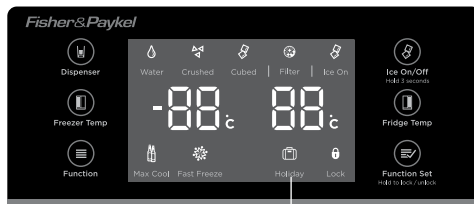

Holiday

To turn on

- 1 Press Function until the Holiday icon is selected.
- 2 Press Function Set , the Holiday function will be activated.

To turn off

- 1 Press Function until the Holiday icon is selected.
- 2 Press Function Set , the Holiday icon will turn off. Holiday function is now deactivated.

Max Cool

This function is designed to chill food quickly to retain freshness and quality. Use this feature before putting large quantities of food into the fridge compartment.

The Max Cool function will automatically deactivate once the fridge compartment has reached the set temperature.

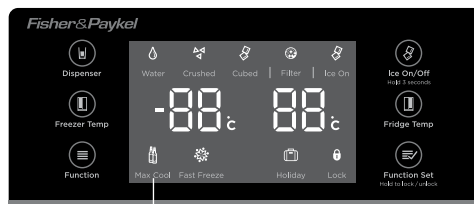

Max Cool

To turn on

- 1 Press Function until the Max Cool icon is selected.
- 2 Press Function Set , the Max Cool function will activate.

To turn off, before automatic deactivation

- 1 Press Function until the Max Cool icon is selected.
- 2 Press Function Set , the Max Cool icon will turn off. The Max Cool function is now deactivated.

IMPORTANT!

You cannot adjust the temperature settings when in Fast Freeze or when Lock has been activated. If you try to adjust the settings under these conditions, the special function icon beside the freezer temperature display will blink, and a beep will sound to indicate that the adjustment cannot be made at this time.

Fast Freeze

This function is designed to freeze food quickly to ensure freshness, texture and taste are retained during the freezing process.



The Fast Freeze function will automatically deactivate after a set time period.

Use this feature before putting large quantities of food into the freezer (for example after food shopping). For best results we recommend that the Fast Freeze function be turned on 12 hours before food is placed into the freezer.





Fast Freeze

To turn on



- ① Press Function  until the Fast Freeze icon is selected.
- ② Press Function Set , the Fast Freeze function will activate.

To turn off, before automatic deactivation

- ① Press Function  until the Fast Freeze icon is selected.
- ② Press Function Set , the Fast Freeze icon will turn off. The Fast Freeze function is now deactivated.

OPERATING INSTRUCTIONS - ICE & WATER CONTROL PANEL

Adjusting the fridge temperature.



- 1 Press . The fridge temperature display will start blinking, indicating that the fridge is in the temperature setting mode.
- 2 Press  to scroll through the fridge temperature range from 9°C to 1°C.

When the desired temperature is displayed, wait 5 seconds. The blinking will stop and the temperature will be set. Alternatively press any other button on the control panel within 5 seconds to set the temperature.



Fridge Temperature

Adjusting the freezer temperature

- 1 Press . The freezer temperature display will start blinking, indicating that the freezer is in the temperature setting mode.
- 2 Press  to scroll through the freezer temperature range from -14°C to -24°C.

When the desired temperature is displayed, wait 5 seconds. The blinking will stop and the temperature will be set. Alternatively press any other button on the control panel within 5 seconds to set the temperature.

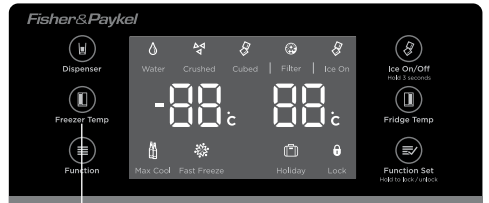

Freezer Temperature

Dispenser button

Press  to scroll through dispensing options: water, crushed ice or cubed ice. Once an icon is illuminated the dispensing mode will change to the function selected.



Dispenser

Ice On/Off

To turn on

Press and hold  for three seconds. The Ice On icon will turn on, indicating that the ice maker is now functioning.

To turn off

Press and hold  for three seconds. The icon will turn off, indicating that the ice maker is now off.



Ice On/Off

Non Ice & Water control panel

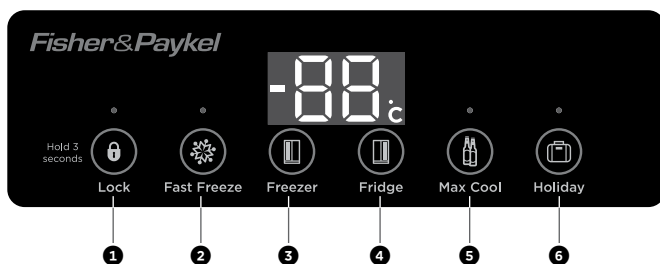

Non Ice & Water control panel

- ① Lock button
- ② Fast Freeze button
- ③ Freezer temperature button
- ④ Fridge temperature button
- ⑤ Max Cool button
- ⑥ Holiday button

Lock

This feature will lock the temperature and function settings, preventing these from being changed. This is useful when cleaning your refrigerator. When locked, the Lock icon will blink and a beep will sound.

To turn on

Press and hold  for 3 seconds, a white LED will turn on above Lock icon. The refrigerator settings will be locked.

To turn off

Press and hold  for 3 seconds, the LED above the Lock icon LED will turn off. The refrigerator settings will be unlocked.



Holiday

IMPORTANT!

Before selecting the holiday function remove all perishable food and drink from the fridge compartment as perishable items may become unsafe to consume.

This feature allows you to leave the fridge section unused while the freezer section operates as normal. When in this function, the fridge temperature will be automatically set to 17°C.

To turn on

Press , a white LED will turn on above the Holiday icon. The Holiday function is now activated.

To turn off

Press . The LED above the Holiday icon will turn off. The Holiday function is now deactivated.

Max Cool

This function is to chill food quickly to retain freshness and quality. Use this feature before putting large quantities of food into the fridge compartment.

The Max Cool function will automatically deactivate once the fridge compartment has reached the set temperature.

To turn on

Press . A white LED will turn on above the Max Cool icon. The Max Cool function is now activated.

To turn off, before automatic deactivation

Press . The LED above the Max Cool icon will turn off. The Max Cool function is now deactivated.

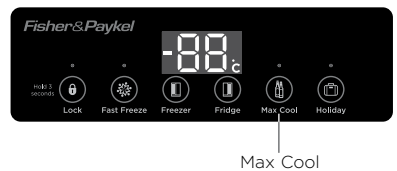

Fast Freeze

This function is designed to freeze food quickly to ensure freshness, texture and taste are retained during the freezing process.

The Fast Freeze function will automatically deactivate after a set time duration.

Use this feature before putting large quantities of food in to the freezer (for example after food shopping). For best results we recommend that the Fast Freeze function be turned on 12 hours before food is placed into the freezer.



To turn on

Press , a white LED will turn on above the Fast Freeze icon. The Fast Freeze function is now activated.

To turn off, before automatic deactivation



Press . The LED above the Fast Freeze icon will turn off. The Fast Freeze function is now deactivated.

Adjusting the fridge temperature

- 1 Press . The fridge temperature display will start blinking, indicating that the fridge is in the temperature setting mode.
- 2 Press  to scroll through the fridge temperature range from 9°C to 1°C.

When the desired temperature is displayed, wait 5 seconds. The blinking will stop and the temperature will be set. Alternatively press any other button on the control panel within 5 seconds to set the temperature.

Adjusting the freezer temperature

- 1 Press . The Freezer temperature display will start blinking, indicating that the freezer section is in the temperature setting mode.
- 2 Press  to scroll through the freezer temperature range from -14°C to -24°C.

When the desired temperature is displayed, wait 5 seconds. The blinking will stop and the temperature will be set. Alternatively press any other button on the control panel within 5 seconds to set the temperature.

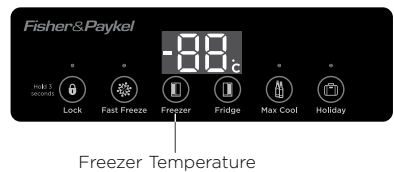
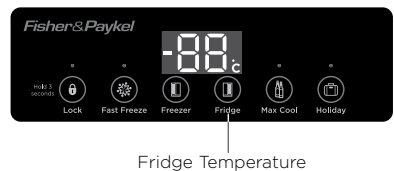
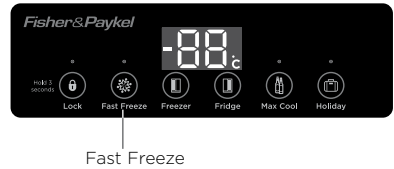

USING YOUR WATER DISPENSER / ICE MAKER - ICE & WATER

First use of the ice maker/water dispenser



- Check your refrigerator is switched on and has been cooling for at least 2 hours before use (refer to page 21 – The temperature of your refrigerator and freezer).
- Check that the water isolation tap has been connected and turned on.
- Press dispenser pad and discard the first 3 L of water, stopping intermittently to remove trapped air in the system. Failure to do this will result in excessive dripping from your dispenser. This will make sure that the pipes are cleared. If in doubt, keep re-using the dispenser until the water runs clear.
- Please discard the first few batches of ice after start up.

Note: the first time the water dispenser is used, there will be a 1 – 2 minute delay while the tank fills, before water is dispensed.

Storing ice for extended periods

Storing ice for long periods of time can affect its appearance and odour. We recommend that you dispose of any ice which has been stored for extended periods and remove and clean the icebox. Allow the ice box to dry thoroughly and cool down before replacing it back into the appliance to prevent ice from sticking to the bin.

Water filter

- The Filter icon  on the control panel will appear when the filter needs replacing. To maintain water quality we recommend the water filter be replaced every 6 months. Replace the water filter as per manufacturer's instructions or follow instructions below. After changing, press the Function button  for 3 seconds, the Filter icon will disappear and the filter timer will reset.
- Replacement cartridges are available from your Fisher & Paykel Service Agent (Kemflo Aicro filter part number 0060823485).

To replace the water filter

- Turn off the water supply.
- Remove the locking key at one end of the filter and then disconnect the water tube. Repeat on the other end of the filter.
- To fit the new filter insert the water tube at the inlet end of the filter, secure with locking clip and flush 19 L (5 gal) of water through the filter. Note the flow direction on the filter (see page 14). Check for leaks.
- Turn off water supply and connect water tube to the outlet end of the filter, secure with locking clip.

IMPORTANT

- **To avoid serious illness or death, do not use water of unsafe or of unknown quality.**
- **The water filter cartridge needs to be changed when the Filter icon  appears on the interface panel or after 6 months of use.**
- **If the water filtration system has been allowed to freeze, replace filter cartridge.**
- **Filter replacement is the consumer's responsibility and will not be covered by the Manufacturer's Warranty except in the case of faulty parts or materials within the filter cartridge.**
- **If the water has not been dispensed for some time or has an unpleasant taste or odour, flush 10 L of water through the system. If unpleasant taste or odour persists, fit a new filter cartridge.**

Removing and replacing the ice box

To remove the icebox, lift the box and then pull towards you, releasing the unit (Fig.10).

Note: water moisture may have condensed and frozen the icebox in place.

When replacing the ice bin, if it does not fit easily, remove the box and turn the cam mechanism 90° clockwise (Fig.11). Reinstall the icebox, making sure that the catch on the tray fits into the shelf slot.

The volume of the icebox equals the quantity of ice cubes, which the appliance can make in one day. Occasionally a small number of ice cubes may remain inside the box. If the ice gets stuck, this will result in abnormal operation of the ice cube maker. To avoid this problem, remove the icebox and rearrange the ice cubes, and remove the ice cubes which cannot be separated. You may hear ice being dropped into the storage compartment. This is normal.

IMPORTANT!

- **Always keep the ice cube outlet clean and clear of obstructions.**
- **Turning the ice maker off and removing the icebox enables extra space for food storage. Install the additional door shelf at the position above the inlet on the freezer door (Fig.12).**
- **Avoid contact with the moving parts of the ice maker and do not place your fingers on the automatic ice making mechanism while the refrigerator is in operation.**
- **Do not use ice cubes which have become discoloured, usually appearing a greenish-blue. If discolouration is observed, contact Fisher & Paykel Customer Care to arrange a service visit.**
- **Ensure the ice maker is connected to the filter and to a potable water supply.**
- **Installation of the water connection must be completed by a Fisher & Paykel trained and supported service technician or qualified plumber.**

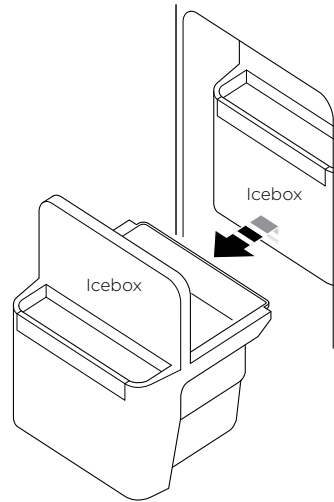

Fig.10 Removing icebox

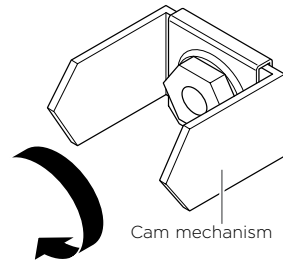

Fig.11 Rotating cam mechanism

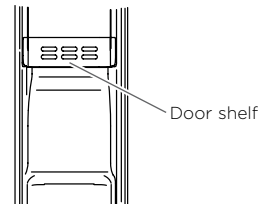

Fig.12 Installation of extra door shelf

SPECIAL FEATURES

Fruit and vegetable bins

The fruit and vegetable bin provides a humid environment for your produce ensuring moisture and nutrients are retained, and your fruit and vegetables are kept fresher for longer.

To remove the bin, pull it out until it stops, then lift and continue to slide the bin until it is fully extended.

Fruit and vegetable bin humidity slide

The bin has a humidity control slide that can be adjusted to the fruit or vegetable setting depending on what is being stored in the bins.

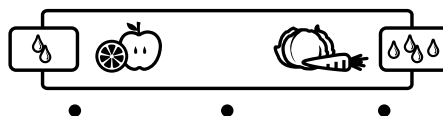

Humidity Control graphic

- If you are storing fruit, set the humidity slide to the fruit setting (left side).
- If you are storing vegetables, set the humidity slide to the vegetable setting (right side).
- If you are storing a mixture of fruit and vegetables, position the humidity slide in the centre.

Door alarms

If the refrigerator or freezer door is left open the alarm will beep at regular intervals to remind you to close the door.

Fault alarms

In the unlikely event of a fault, a fault code will be displayed on the control panel. Please take note of the fault code and contact our Customer Care Centre. Contact details are in the back of this book.

Water dispenser (Ice & Water models only)

The water dispenser is located on the front of the freezer door. When pressing the dispenser pad, the selection chosen on the control panel will dispense (water, cubed ice or crushed ice).

Drip tray (Ice & Water models only)

The tray at the bottom of the dispenser is designed to collect small spills. It has been designed to be removed for cleaning purposes. It does not drain; to empty remove the drip tray and wipe up overflow.

CLEANING CARE - EXTERIOR

Exterior

Stainless exterior doors

- It is important when cleaning the exterior door surface of your refrigerator, to only use liquid dishwashing detergent dissolved in warm water and a soft cloth.
- Dry the door with a clean, lint free cloth.
- The use of any abrasive or stainless steel cleaners and solvents will damage the door surface.

Other exterior surfaces

- Clean all other exterior surfaces with a mix of warm water and liquid dishwashing detergent, and a soft cloth.
- If necessary, clean the magnetic door gasket and the centre door gaskets with an old toothbrush, warm water and liquid dishwashing detergent.

Water dispenser pad (Ice & Water models only)

Clean the dispenser pad and drip tray with a mixture of warm water and a mild detergent. Dry thoroughly.

CLEANING CARE - INTERIOR

Interior

- It is important to keep the interior of the refrigerator and freezer clean to help prevent food from becoming contaminated during storage.
- The amount and types of food stored determines how often cleaning should be carried out (ideally once every 1 to 2 weeks) in the refrigerator.
- Remove the shelves, door shelves and bins and rinse these parts in a mixture of warm water and liquid dishwashing detergent. Rinse and dry the shelves and bins thoroughly before replacing them into the refrigerator.
- Wipe over the interior surfaces with a mixture of warm water and liquid dishwashing detergent or baking soda dissolved in warm water (add 1 tsp of baking soda to each 500 mls of water). Rinse with clean water.
- To help remove “old stale refrigerator” smells add a few drops of vanilla essence or vinegar to the water before cleaning.
- Do not use harsh, abrasive cloths or cleaners or highly perfumed, strong smelling cleaners or solvents on any part of the refrigerator as they can cause damage.

Glass shelves

Clean with warm water and detergent or a glass cleaner. If cleaning the shelves without removing from the cabinet, use only warm water and detergent as a glass cleaner can damage the plastic components of your refrigerator.

To remove the shelf, tilt the front upwards so that the restraining pegs are clear of the side guides and pull towards you. Keep the shelf tilted to allow the retaining stops to clear the side guides.

When repositioning, make sure the shelf is pushed back fully and the retaining stops have located securely.

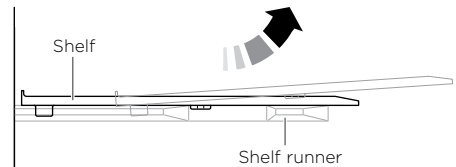

Removing fridge shelf

IMPORTANT!

When adjusting the height of a shelf, first remove any food placed on the shelf.

STORING FOOD IN YOUR REFRIGERATOR

Your refrigerator helps to extend the storage times of fresh perishable foods. The cold temperature slows down the major causes of food spoilage – namely, the growth of bacteria, moulds and yeasts, and any chemical and physical reactions.

Fresh food care

The quality of food before it is placed in the refrigerator is critical to successful storage. For best results:

- Select foods that are very fresh and of high quality.
- Buy only the amount that you will use within the recommended storage time. If you buy extra, plan to freeze it.
- Ensure that food is well wrapped or covered before it is stored. This will prevent food from dehydrating, deteriorating in colour or losing flavour and will help maintain freshness. It will also prevent odour transfer. Fruit and vegetables need not be wrapped provided they are stored in the vegetable bins of the refrigerator.
- Make sure that strong smelling foods are wrapped or covered and stored away from foods such as butter, milk and cream which can be easily tainted by strong odours.
- Refrigerate fresh, perishable foods as soon as possible after purchase. If left at room temperature for any length of time the rate of deterioration will be accelerated.
- Avoid placing food directly in front of air outlets, as it may freeze and cold air needs to circulate to maintain safe food storage.
- Do not open the refrigerator door unnecessarily.
- Cool hot foods down before placing them in the refrigerator. This should be done quickly. It can be aided by placing the container of food in a bowl of ice and water; renew the ice as necessary. (Note hot containers may damage shelves and walls of the refrigerator).
- Store raw and cooked food in separate containers or packaging to prevent cross contamination.

In addition:

- Keep the refrigerator clean. Wipe the inside walls and shelves frequently (refer to 'Cleaning Care') and place only clean containers in the refrigerator.
- Keep a close check on the quality of food in your refrigerator. Discard any food that shows signs of spoilage. Pay particular attention to meat, fish and poultry, as these foods are highly perishable. Use food within the recommended storage times.

Dairy foods and eggs

- Most pre-packed dairy foods have a recommended 'use by/best before/best by' date stamped on them. Store them in the refrigerator and use within the recommended time.
- Butter can become easily tainted by strong smelling foods so it is best stored in a sealed container.
- Eggs should be stored in the refrigerator. For best results, especially when baking, remove the eggs from the refrigerator two hours before they are to be used.

STORING FOOD IN YOUR REFRIGERATOR

Red meat

- Place fresh red meat on a plate and loosely cover with waxed paper, plastic wrap or foil.
- Store cooked and raw meat on separate plates. This will prevent any juices lost from the raw meat contaminating the cooked product.
- Delicatessen meats should be used within the recommended storage time.

Poultry

- Fresh whole birds should be rinsed inside and out with cold running water. Dry and place on a plate. Cover loosely with plastic wrap or foil.
- Poultry pieces should also be stored this way. Whole poultry should never be stuffed until just before cooking, otherwise food poisoning may result.
- Cool and refrigerate cooked poultry quickly. Remove stuffing from poultry and store separately.

Fish and seafood

- Whole fish and fillets should be used on the day of purchase. Until required, refrigerate on a plate loosely covered with plastic wrap, waxed paper or foil.
- If storing overnight or longer, take particular care to select very fresh fish. Whole fish should be rinsed in cold water to remove loose scales and dirt and then patted dry with paper towels. Place whole fish or fillets in a sealed plastic bag.
- Keep shellfish chilled at all times. Use within 1 - 2 days.

Precooked foods and leftovers

- These should be stored in suitable covered containers so that the food will not dry out.
- Keep for only 1 - 2 days.
- Reheat leftovers only once and until steaming hot.

Fruit and vegetable bins

- Although most fruit and vegetables keep best at low temperatures, take care not to store the following at temperatures less than 7°C for long periods: Citrus fruit, tropical fruit, tomatoes, cucumbers.
- Undesirable changes will occur at low temperatures such as softening of the flesh, browning, accelerated decaying and/or loss of flavour.
- Do not refrigerate avocados (until they are ripe), bananas, mangoes or pepinos.
- If possible store fruit and vegetables separately, ie fruit in one bin and vegetables in the other.
- Each fruit and vegetable bin has a humidity control slide that can be adjusted depending on what is stored in the bins. For more information on using the Humidity Control refer to page 27.

STORING FOOD IN YOUR FREEZER

We recommend the use of temperatures -18°C or colder to store food. This means that the food can be kept for longer periods than when refrigeration temperatures are used. This is because the growth of bacteria, moulds and yeasts are stopped, and chemical and physical reactions are severely restricted at such low temperatures.

Frozen food care

For best results:

- Choose only high quality foods that freeze well.
- For best results store at -18°C or colder. Take care to maintain this low storage temperature, eg try to avoid opening the freezer door unnecessarily. If your ice cream is soft you are running your freezer too warm.
- Leave space at the top of containers, glass jars or plastic bags containing liquids or semi-solid foods. These expand as they freeze. Usually 20 - 50 mm head space is recommended. Seal. Ideally, remove all the air from the package after food is frozen.
- Packages or containers of solid foods should have the air removed from them and be sealed tightly before freezing.
- Use the Fast Freeze function when freezing fresh food. This helps to speed up the freezing process, giving optimum freezing results. It is recommended that the function is activated approximately 2 hours before required. For more information refer to page 24.
- Freeze immediately or as quickly as possible. Freeze only small quantities of food at any one time. For best results we recommend that only 1 kg of food be frozen per 25 L of freezer storage volume at any one time. (About 3 kg in small freezers and 4 kg in larger freezers). For faster freezing, we recommend that fresh food is placed at the top of the freezer compartment close to the air vent.
- Thaw foods preferably in a refrigerator, or using a microwave oven or multifunction oven.
- Keep a constant turnover of food. Use older items of food first and do not exceed recommended storage times.
- Use good quality freezer proof packaging to maintain food quality.
- If food is only covered in plastic film place inside a freezer-proof plastic bag.

Recommended freezer storage times

These times should not be exceeded.

MONTHS	TYPE OF FOOD STORED
1	Bacon, casseroles, milk
2	Bread, ice cream, sausages, pies - (meat and fruit), prepared shellfish, oily fish
3	Non-oily fish, shellfish, pizza, scones and muffins
4	Ham, cakes, biscuits, beef and lamb chops, poultry pieces
6	Butter, vegetables (blanched), eggs whole and yolks, cooked crayfish, minced meat (raw), pork (raw)
12	Fruit (dry or in syrup), egg whites, beef (raw), whole chicken, lamb (raw), fruit cakes

STORING FOOD IN YOUR FREEZER

Meat, poultry and game

- Do not try to freeze more than 1 kg meat per 25 L of freezer storage volume at any one time. Meat must be frozen quickly in order to maintain its texture.
- Do not stuff poultry before freezing.
- Red meat can be cooked from frozen, or from the partly or completely thawed states. Remember to allow extra cooking time if cooking from frozen.
- Always thaw poultry completely before cooking.

Fish

- Fish is best frozen commercially. If, however, you do want to freeze fish at home, make sure the fish is very fresh and of high quality.
- Clean, scale and preferably leave whole. All fish should be wrapped in two layers of packaging as depending on the type of fish, odours and flavours can be readily transferred either to or from it. Seal well.
- For best results, cook from either the frozen or partly thawed state.

Fruit

- Choose high quality, mature, and ready to eat fruit. Preferably select varieties recommended for freezing.
- Avoid unripe and over-ripe fruit.
- The way fruit is packed depends on how it is to be used. Fruits packed in syrup are ideal for desserts, whereas fruits packed without sugar are better used for cooking. Most fruits can be stored for 8 – 12 months.

Vegetables

- Most vegetables freeze well, although 'salad' vegetables lose their crispness. Other vegetables, eg celery, onion and tomatoes, should only be used in cooked dishes as they soften on freezing.
- Freeze only high quality, mature, ready-to-eat vegetables.
- Sort and discard any vegetables that are damaged.
- It is necessary to blanch most raw vegetables prior to freezing.
- Blanching involves a short cooking period during which vegetable enzymes are destroyed. If these enzymes are not destroyed they cause undesirable physical and chemical changes during freezer storage.
- Vegetables can be blanched in boiling water, steam or microwave oven. If using boiling water, boil vegetables for 2 – 4 minutes and cool quickly.
- In general, frozen vegetables are best cooked from their frozen state.

Prepared and cooked foods

- Most cooked foods can be frozen but it is not recommended to freeze the following: Cooked egg white, custards, cream fillings and milk puddings, gelatine or jelly-like dishes, mayonnaise and similar salad dressings, meringue toppings. These tend to separate on thawing.

TROUBLESHOOTING

If there is a problem with your appliance, please check the following points before contacting your local Fisher & Paykel trained and supported service technician or the Customer Care Centre.

Product parts and accessories can be purchased through Fisher & Paykel Customer Care or online at www.fisherpaykel.com (this service is available to selected markets only).

All models

PROBLEM	POSSIBLE CAUSES	WHAT TO DO
Appliance does not operate.	No electricity at power outlet.	Check that the plug is correctly connected and power switched on.
		Check another appliance at the same outlet.
		Check house fuse.
Light not working.	Light not functioning.	The LED light cannot be serviced by the user. Contact your Fisher & Paykel Dealer or Fisher & Paykel trained and supported service technician.
	Refrigerator not working.	Check refrigerator is turned on at wall.
Motor operates for long periods.	Hot weather.	Minimise door openings to allow temperature to stabilise.
	Frequent door openings.	
	Large amount of food recently added.	
	Temperature control set too low.	See 'Operating Instructions' section (pages 18 - 24).
	Doors not sealing properly.	Check that cabinet is level and gasket seals are clean.
Storage compartments too warm.	Temperature setting not correct.	See 'Operating Instructions' section (pages 18 - 24).
	Frequent door openings.	Minimise door openings to allow temperature to stabilise.
	Large amount of food recently added.	
Food freezing in the fridge compartment.	Temperature setting not correct.	See 'Operating Instructions' section (pages 18 - 24).
	Food placed directly in front of air outlets.	Move chill sensitive foods away from the centre back of the shelves.
Unfamiliar noises.	Cabinet not stable or level.	See 'Installation Instructions' (pages 7 - 14).
	Freezer is defrosting.	

TROUBLESHOOTING

All models

PROBLEM	POSSIBLE CAUSES	WHAT TO DO
Water in the vegetable bins.	Condensation is formed by the water produced by fruit and vegetables.	A small amount of condensation is beneficial for fruit and vegetable storage. Wipe out water with a cloth.
Exterior of cabinet is warm.	This is normal.	
Condensation on outside of refrigerator/freezer.	Not unusual during periods of high humidity.	Wipe dry.
Condensation inside fridge compartment.	Frequent or long door openings.	Minimise door openings.
	Door gasket leaking.	Check that gasket is sitting flat and sealing tightly.
	Not unusual during periods of high humidity.	Wipe dry.
Door handles out of alignment.	With time and usage, movement may occur.	See 'Installation instructions' (page 12).
Tray/bin does not slide in and out evenly.	Packaging trapped.	Check to ensure no food or packaging is trapped behind the tray/bin.
Taste of odour in ice cubes.	Transfer of odour/taste from strong smelling foods.	Wrap or cover strong smelling foods.
Excessive gasket noise.	May be due to a build up of dirt and/or grime.	Clean gasket.
Door not closing.	An obstruction is blocking door closing.	Move obstruction.

TROUBLESHOOTING

Ice & Water models only

PROBLEM	POSSIBLE CAUSES	WHAT TO DO
Automatic ice maker does not work.	Ice maker has not been turned on.	Switch on ice maker (refer to page 21).
	Water supply turned off or not connected.	Connect water supply.
	Freezer compartment not working.	Contact Customer Care.
	Water pressure too low.	Check water pressure.
	Water line kinked/squashed.	Check water line for kinks/squashing.
	Filter clogged.	Water filter may need replacing.
	Ice cubes stick in ice bin.	Remove ice bin, loosen cubes and remove clumped ice. Refit ice box.
Ice cubes have odour/taste.	Unsealed packages may be transmitting odour/taste.	Old cubes need to be discarded. Ensure food packaging is sealed.
	Interior of freezer needs cleaning.	Ice storage bin needs to be emptied and washed. Clean refrigerator (refer to page 29).
	Poor taste from incoming water.	Filter may need changing. A new filter may need to be installed.
Slow ice cube freezing.	Door may have been left ajar.	Close door.
	Freezer compartment too warm.	Turn temperature to a colder setting (refer to pages 18 - 24).
Wet ice/ ice clumping.	Low water pressure.	Check water pressure.
	Filter blocked.	Replace filter (refer to page 25).
	Long freezer door openings.	Gently tap ice to unstick or, if large clumps occur, empty ice bin and make new ice.
	High ambient temperature.	
	Ice bin left out of freezer compartment for a length of time.	
	Ice will stick together over time.	

TROUBLESHOOTING

Ice & Water models only

PROBLEM	POSSIBLE CAUSES	WHAT TO DO
Water has poor taste/odour.	Refrigerator not used for an extended period.	Dispense 3 L of water so fresh water supply is replenished. Note: do not dispense continuously for longer than 1 min. Stop intermittently during dispensing.
Water dispenser does not work.	Water supply turned off or not connected.	Turn water on. Press dispenser for 1 minute to remove trapped air from water line and to fill the water system.
	Supply line may be blocked.	Check supply for kinks or leaks.
	On first installation there may be air in water system.	To remove air, run 3 L of water through the dispenser. Note: do not dispense continuously for longer than 1 min. Stop intermittently during dispensing.
	Filter may be blocked and need replacing.	Replace filter (see back of this booklet for Customer Care contact details).
	Water frozen in tank.	Increase temperature to a warmer setting in fresh food compartment and freezer.
Water in first glass is warm.	Water dispenser not used for extended period.	Discard first glass of water dispensed.
	Tank capacity used recently.	Allow water time to cool.
Drips overflow drip-shelf.	Air trapped in tank.	Flush 3 L water through dispenser, stopping intermittently.
	New filter installed.	Flush 19 L water through filter and then 3 L through dispenser.
Water flow rate has slowed down.	Filter cartridge is restricted.	Replace filter as soon as possible (see page 25).
Ice buildup inside freezer compartment.	Freezer door not closing tightly.	Arrange items in freezer so door can close tightly. Check and clean door gasket seal.
Ice maker sounds.	Normal ice maker operation.	Refer to refrigerator sounds (refer to page 27).
Small or large ice cubes.	Insufficient or excessive water pressure.	Check water pressure.

MANUFACTURER'S WARRANTY

You automatically receive a 2 year Manufacturer's Warranty with the purchase of this refrigerator covering parts and labour for servicing within the countries New Zealand, Australia, the United Kingdom and the Republic of Ireland. All other countries are excluded.

Fisher & Paykel undertakes to:

Repair or, at its option, replace without cost to the owner either for material or labour any part of the product, the serial number of which appears on the product, which is found to be defective within TWO YEARS of the date of purchase.

Note: this Manufacturer's Warranty is an extra benefit and does not affect your legal rights.

This Manufacturer's Warranty DOES NOT cover

- Ⓐ Service calls which are not related to any defect in the product. The cost of a service call will be charged if the problem is not found to be a product fault. For example:
 - ① Correcting the installation of the product.
 - ② Instructing you how to use the product.
 - ③ Replacing house fuses or correcting house wiring or plumbing.
 - ④ Correcting fault(s) caused by the user.
 - ⑤ Noise or vibration that is considered normal, eg drain/fan sounds, refrigeration noises or user warning beeps.
 - ⑥ Correcting damage caused by pests, eg rats, cockroaches, etc.
 - ⑦ Replacement light bulbs.
- Ⓑ Defects caused by factors other than:
 - ① Normal domestic use; or
 - ② Use in accordance with the product's user guide.
- Ⓒ Defects to the product caused by accident, neglect, misuse or 'act of God'.
- Ⓓ The cost of repairs carried out by non-trained and supported service technicians or the cost of correcting such repairs.
- Ⓔ Normal recommended maintenance as set out in the product's user guide.
- Ⓕ Repairs when the appliance has been dismantled, repaired or serviced by other than a Fisher & Paykel trained and supported service technician or the selling dealer.
- Ⓖ Pick-up and delivery.
- Ⓗ Transportation or travelling costs involved in the repair when the product is installed outside the Fisher & Paykel trained and supported service technician's normal service area.
- Ⓘ Filter replacement except in the case of faulty parts or materials within the filter cartridge.
- Ⓣ Damage (including water damage) caused by faulty installation or plumbing.

Nothing in this Manufacturer's Warranty is intended to, or does limit, any rights you may have under law to recover the costs of inspecting or returning the goods to us.

This product has been designed for use in a normal domestic (residential) environment. This product is not designed for any commercial use (whatsoever). Any commercial use by a customer will affect this product's Manufacturer's Warranty.

MANUFACTURER'S WARRANTY

Service under this Manufacturer's Warranty must be provided by a Fisher & Paykel trained and supported service technician (refer to the 'Customer care' section at the back of this book). Such service shall be provided during normal business hours. This Manufacturer's Warranty certificate should be shown when making any claim.

For Australian Customers

This Manufacturer's Warranty is an extra benefit and does not affect your legal rights. Our goods come with guarantees that cannot be excluded under the Australian Consumer Law. You are entitled to a replacement or refund for a major failure and compensation for any other reasonably foreseeable loss or damage. You are also entitled to have the goods repaired or replaced if the goods fail to be of acceptable quality and the failure does not amount to a major failure.

Please keep this user guide in a safe place.

CUSTOMER CARE

Before you call for service or assistance...

Check the things you can do yourself. Refer to the installation instructions and your user guide and check that:

- ① Your product is correctly installed.
- ② You are familiar with its normal operation.
- ③ You have read the 'Troubleshooting' section at the back of the book.

If after checking these points you still need assistance or parts, please refer to your nearest Fisher & Paykel trained and supported service technician, Customer Care, or contact us through our website www.fisherpaykel.com.

In New Zealand if you need assistance...*

Call your Fisher & Paykel retailer who is trained to provide information on your appliance, or if we can be of any further help, please contact our Customer Care Centre.

Toll Free: 0800 FP CARE or 0800 372 273

Fax: (09) 273 0656

Website: www.fisherpaykel.com

Postal address: Fisher & Paykel Appliances Ltd, PO Box 58550, Botany, Auckland 2163

If you need service...*

Fisher & Paykel has a network of Fisher & Paykel trained and supported service technicians that can carry out any service necessary on your appliance. Our Customer Care Centre can recommend a Fisher & Paykel trained and supported service technician in your area.

In Australia if you need assistance...*

Call the Fisher & Paykel Customer Care Centre and talk to one of our Customer Care Consultants.

Toll Free: 1300 650 590

Fax: (07) 3826 9298

Website: www.fisherpaykel.com

Postal address: Fisher & Paykel Appliances Australia Pty Ltd, PO Box 798, Cleveland QLD 4163

If you need service...*

Fisher & Paykel has a network of Fisher & Paykel trained and supported service technicians that can carry out any service necessary on your appliance. Our Customer Care Centre can recommend a Fisher & Paykel trained and supported service technician in your area.

In the United Kingdom if you need assistance...*

Call the Fisher & Paykel Customer Care Centre and talk to one of our Customer Care Consultants.

Phone: 08000 886 605

Fax: 08000 886 606

Website: www.fisherpaykel.com

Postal address: Fisher & Paykel Appliances Ltd, Maidstone Road, Kingston, Milton Keynes, Buckinghamshire, MK10 0BD

CUSTOMER CARE

In Ireland if you need assistance...*

Phone: 1800 625 174 or 01-8077960

Fax: 1800 635 012

Website: www.fisherpaykel.com

Postal address: Fisher & Paykel Appliances, Unit D2, North Dublin Corporate Park, Swords, Co. Dublin

*If you call, write or contact us via our website please provide: your name and address, model number, serial number, date of purchase and a complete description of the problem. This information is needed in order to better respond to your request for assistance.

Product details can be found on the inside of the fridge compartment, left hand side.

Registration

Register your product with us so we can provide you with the best service possible. To register your product visit our website: **www.fisherpaykel.com**

Complete and keep for safe reference:

Model _____

Serial No. _____

Purchase Date _____

Purchaser _____

Dealer _____

Suburb _____

Town _____

Country _____

EUROPEAN DIRECTIVE 2012/19/EU ON WASTE ELECTRICAL AND ELECTRONIC EQUIPMENT (WEEE)

GB This appliance is marked according to the European directive 2012/19/EU on Waste Electrical and Electronic Equipment (WEEE). By ensuring this product is disposed of correctly, you will help prevent potential negative consequences for the environment and human health, which could otherwise be caused by inappropriate handling of this product.

The symbol  marked on the serial plate, or on the documents accompanying the product, indicates that this appliance cannot be treated as household waste. It shall be handed over to the applicable collection point for the recycling of electrical and electronic equipment. Disposal of the appliance shall be carried out in accordance with the local environment regulations for waste disposal and ensure the refrigerant circuit is not damaged.

For more detailed information about treatment, recovery and recycling of this product, please contact your local city office, your household waste disposal service or your Fisher & Paykel retailer/dealer from whom you purchased this product.

www.fisherpaykel.com

© Fisher & Paykel Appliances 2015. All rights reserved.

The product specifications in this booklet apply to the specific products and models described at the date of issue. Under our policy of continuous product improvement, these specifications may change at any time. You should therefore check with your Dealer to ensure this booklet correctly describes the product currently available.

NZ AU GB IE

842585 B 11.15